



NEET - UG

NATIONAL TESTING AGENCY

Botany

Volume - 1



Contents

1. The Living World	1
2. Biological Classification	23
3. Plant Kingdom	66
4. Morphology of Flowering Plant	94
5. Anatomy of Flowering Plants	125
6. Cell: The Unit of Life	149
7. Cell Cycle and Division	187
8. Transports in plant	200
9. Mineral Nutrition	218
10. Photosynthesis	230
11. Respiration in Plants	247
12. Plant Growth and Development	260

1. The Living World

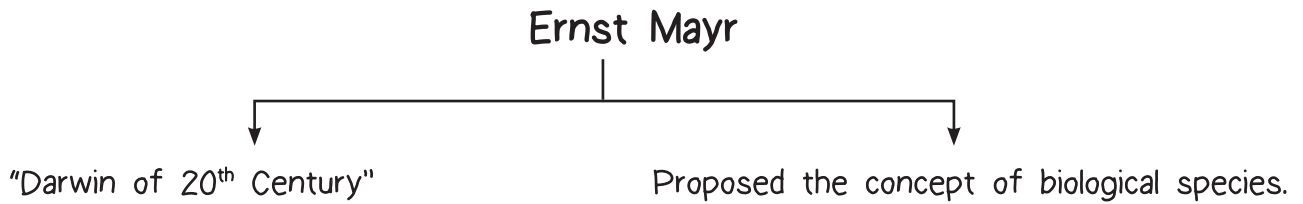

Prize (Triple Crown of Biology)

- * B = Balzan Prize
- * I = International Prize for Biology
- * C = Crafoord Prize

Properties of Living Org

A. GROWTH

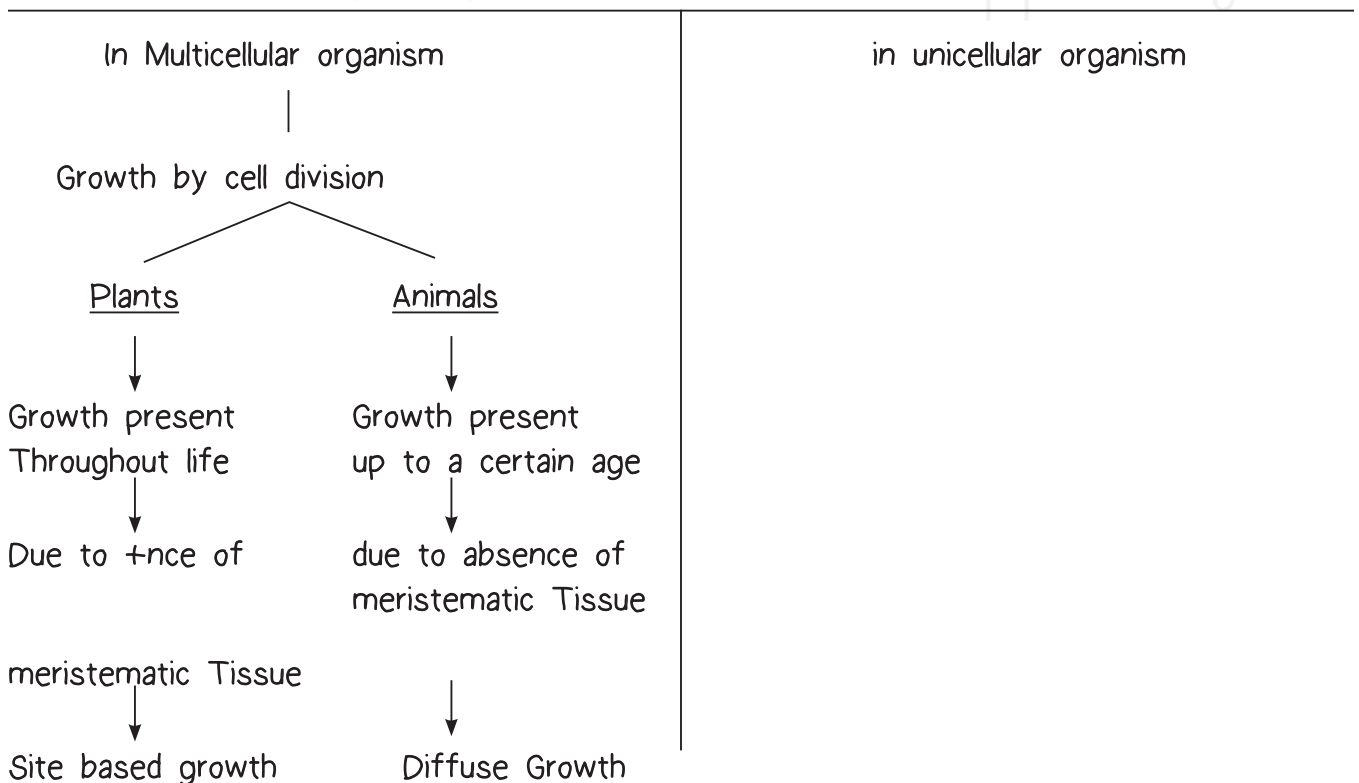
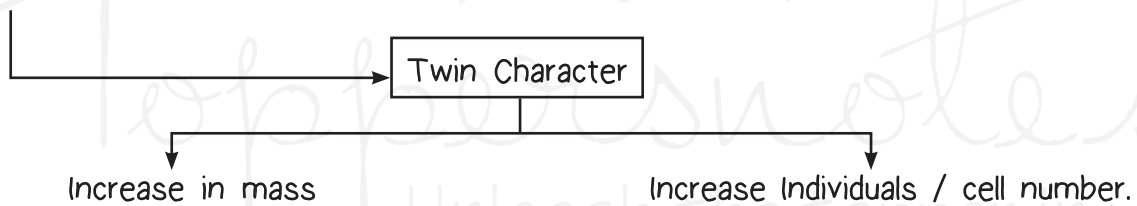

- * Growth and Reproduction are Mutually Exclusive event in Multicellular organism.
- * Growth and Reproduction are Mutually Inclusive event in unicellular organism.

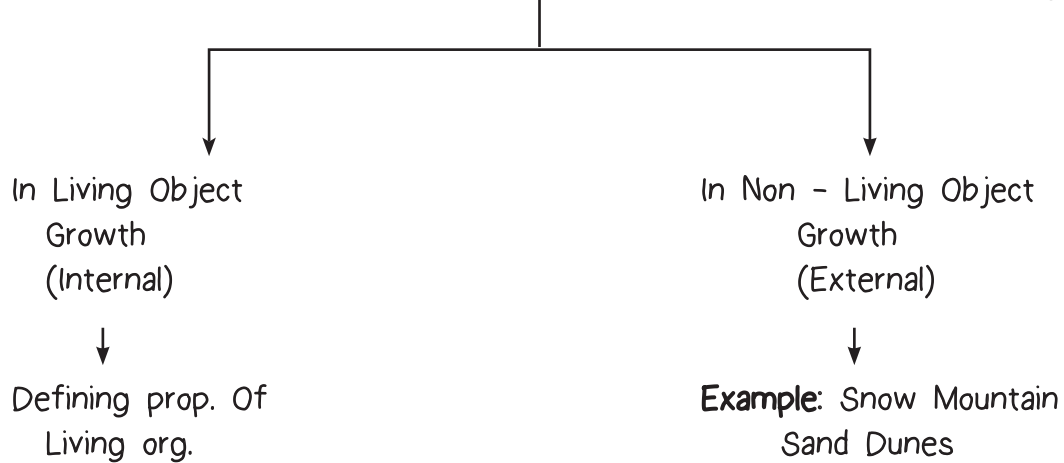

→ Growth is not a defining property of living org.

Reproduction

Biological process in which Parents Participate and produce fertile offspring

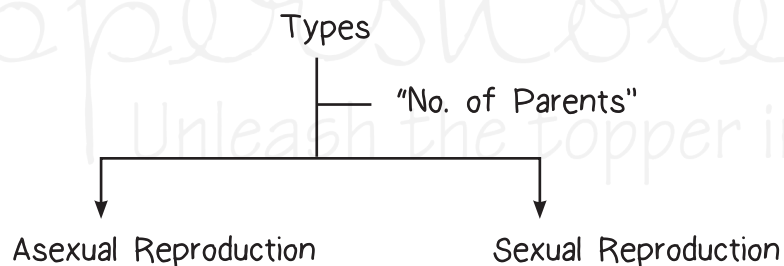

No. of Parents	Single	Double
Gametes formation	√/x	√
Fertilization / syngamy	x	√
Product	Clone	Offspring
Speed	Fast	slow
Special structure involvement	√/x	√

Note: Clone are 100% Morphological and genetically similar to parents Due to the absence of meiosis.

Asexual Reproduction is simple and sexual Reproduction is complex process.

Asexual Rep. (6 types).

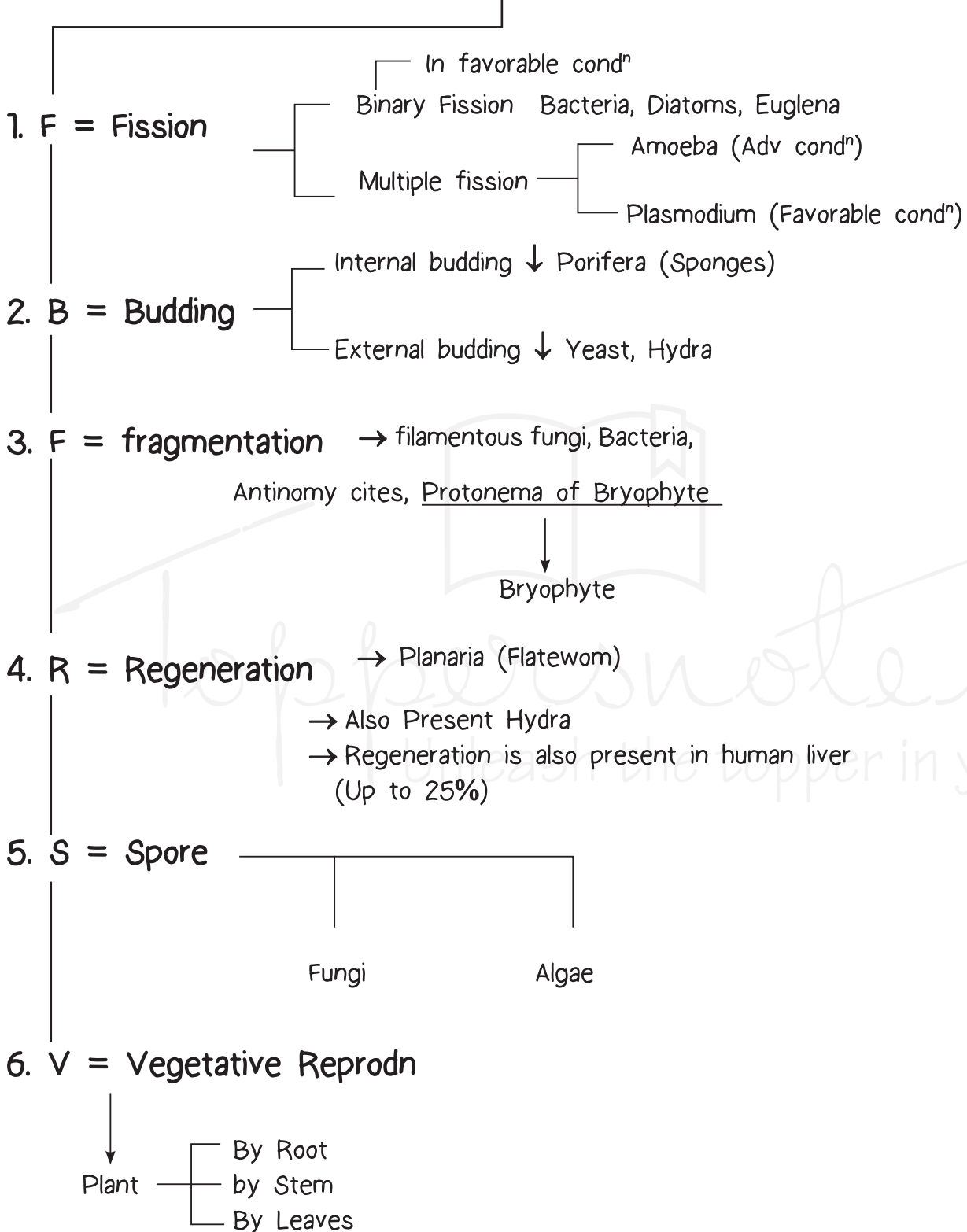

* Reproduction is NOT a defining property of living organisms.

		Living	Reproduction	
1	Mule	Yes	No	Female Horse x Male Donkey
2	Hinny	Yes	No	Male Horse x Female donkey
3	Sterile Male Dron???	Yes	No	
4	Sterile Human	Yes	No	

B. Metabolism

The sum Total of all chemical Rxnⁿ in body

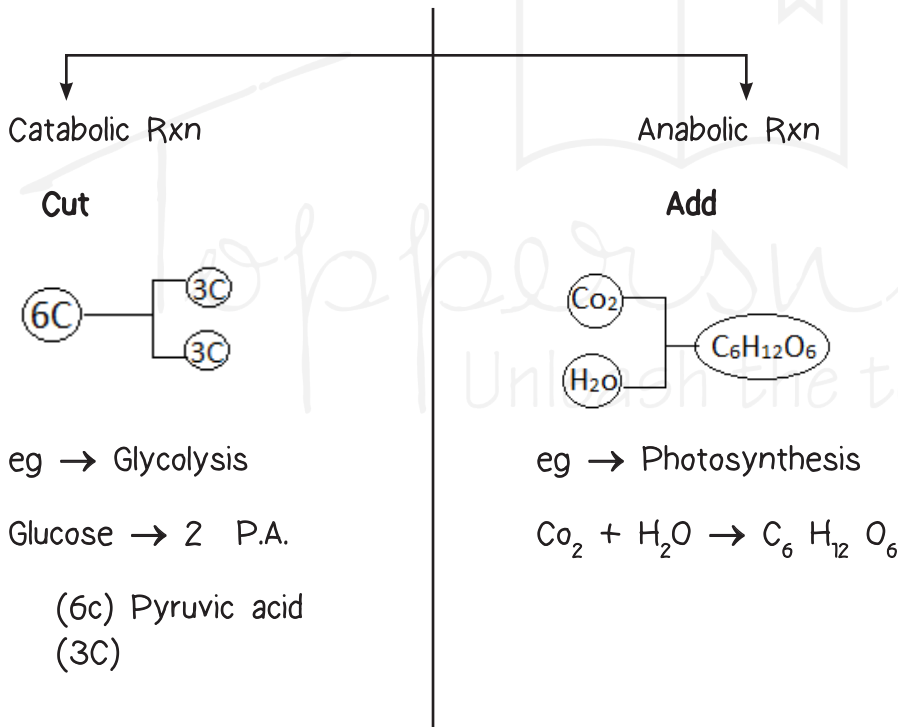

- * Catabolic > Anabolic → -ve Growth
- * Anabolic > Catabolic → +ve Growth

The Living World

* Metabolism is a defining property of living organism

Reaction Outside the Body (In-vitro)

Reaction inside the body (in-vivo)



(in test tube)

(In the cell)



Energy Release

Energy Release

Energy Not used by Test Tube

Energy used by cell



Test Tube act as a Non - living thing

Cell act as a living things

- * In both conditions, rxⁿ are same, but in vitro condition, the byproduct of Rxⁿ (Energy) cannot be used by test tube
∴ test tube acts as a Non-Living Thing.
- * In - vivo condn by - product of Rxⁿ is used by cell which acts as a Living things.
- * All the Metabolic Rxⁿ (In-vitro condn) are living Rxⁿ but not living things.

C. Consciousness

- * Most obvious and complicated feature of Living Organism.
- * Consciousness having 2 steps →
 1. Sense to environmental changes
 2. Respond to environmental changes
- * "Consciousness is the defining property of living org"

e.g. →

- * Bacteria responds to change in
 - PH
 - temperature
 - Humidity

- * Most of the animals, plant respond to
 - Temperature
 - Light

- * Seasonal breeder: the breeding period mainly depends on season.

[Example: Plants and Animal]

Photoperiodic and Vernalization → These are also an example of consciousness.

Self-consciousness

It is Present only in Humans.

- * Consciousness is defining property of living org but self-consciousness is not a defining Property.

Stimulus

- * Any change in environment which can be sensed by organism it can be

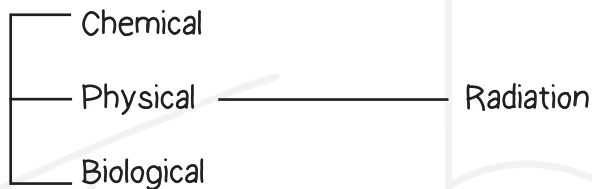

- * "Coma" patient is → living brain dead condition.
- * The level of consciousness in coma patient is less than the threshold Value of consciousness. If this level can recovered by any treatment then that person can respond to any change in environment.

D. Cellular Organization

- * Defining prop. of living org
- * Minimum 1 cell is Present in every living org.

Virus - does not included in living org due to acellular structure.

A. Unicellular → cell → single

B. Multicellular → cell → than 1

1. Growth	—————>	Non - defining property
↳ Ext. Growth	—————>	Non - defining property
↳ Int. Growth	—————>	Defining property
2. Reproduction	—————>	Non - defining property
3. Metabolism	—————>	Defining property
4. Consciousness	—————>	Defining property
↳ Self-cons.	—————>	Non - defining property
5. Cell structure	—————>	Defining property

* Properties of Living tissue is Present in Group of Cells which can interact to each other.

* Living object having the ——— [

- 1. Self-Replication Process
- 2. Evolution
- 3. Consciousness / Respond to external Stimulus

* All human being share a **common gene pool.**

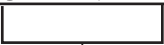

It is the total gene no. / allele in a particular organism's population.

BIO DIVERSITY



Living type.

- * Types of living org in a particular area is called as biodiversity.
- * It mainly depends on types and number of individuals.
- * Total identified living org in the world is about 1.7 - 1.8 million (17-18 lac)

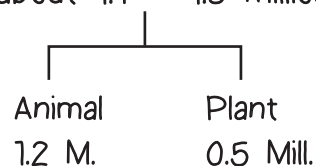

Acc. to scientific study (By Robert Mayr) approx. → 7 million, total organism present in biosphere

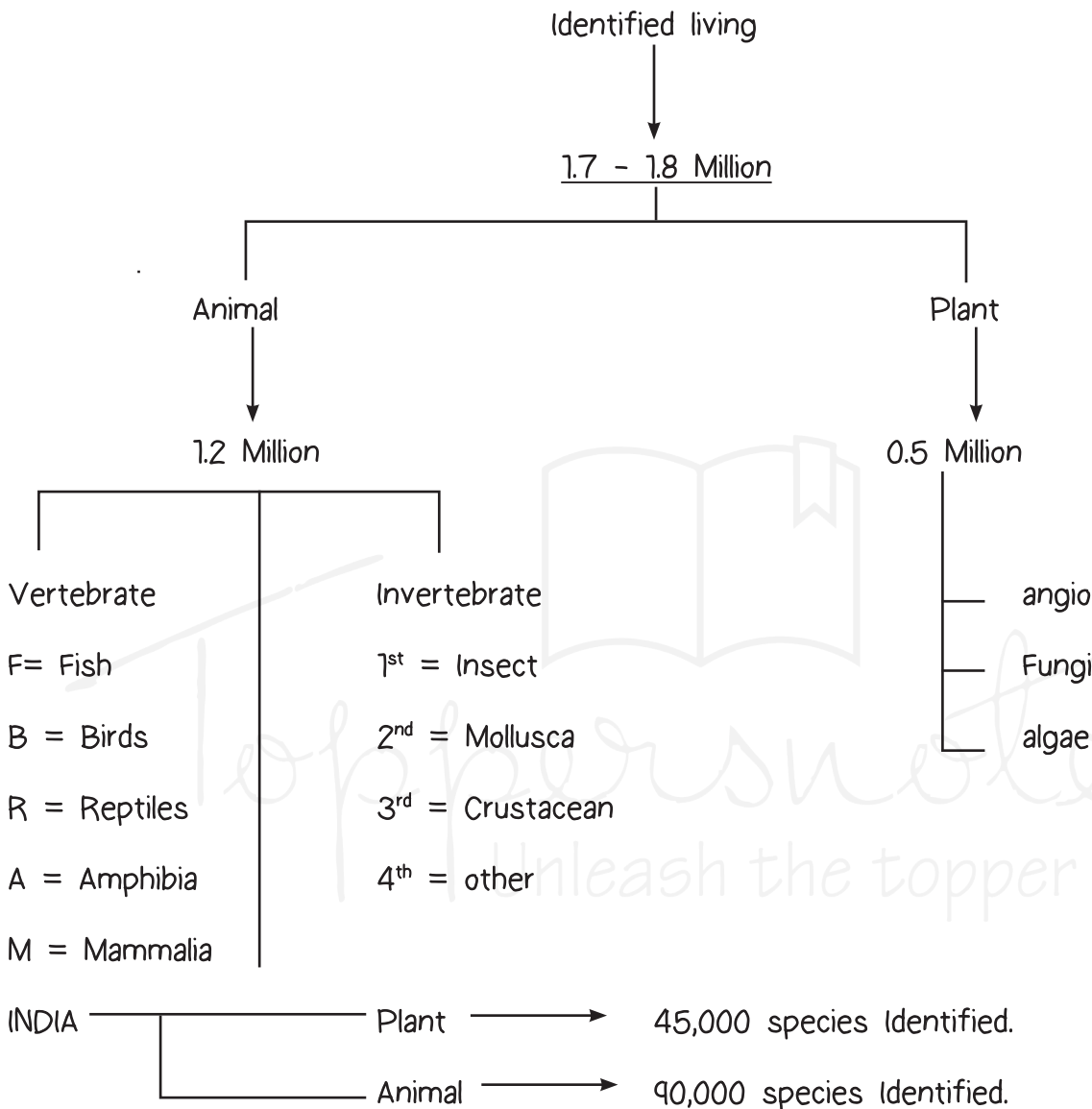

* Approximately 15,000 species Discovered per year.

Reasons for High Biodiversity:

*** Isolation**

It always Decrease the competition b/w org. which leads to Increase biodiversity in particular area.

*** Adaptation**

Responsible for solvability of an org.

The Living World

* Change in Genetic Material:

Which leads to Formation of new Character different from in place of which the initial stage for formation of new species.

* Requirement of classification:

- Easy to study
- Phylogenetical study.

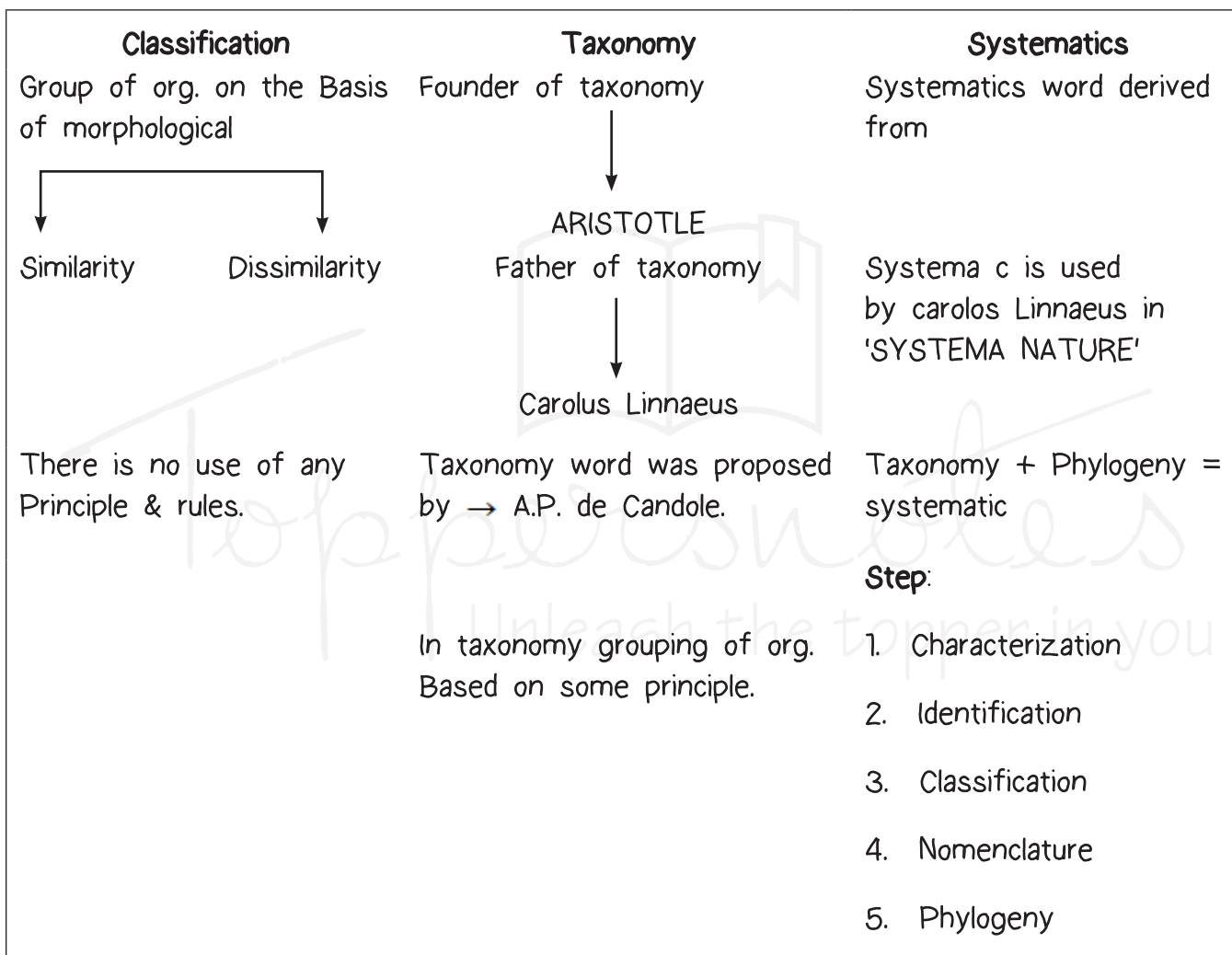

There is no use of any Principle & rules. **Step involved in Taxonomy:**

1. Characterization
2. Identification
3. Classification
4. Nomenclature
5. Type of taxonomy

Classical Taxonomy

Modern (Neo /Bio or New Systematic



Type of taxonomy

1. Classical = Based on only Morphological character. Word proposed by Huxley
2. Modern Taxonomy :
 Based on morphological
 Anatomy + cytological
 + Developmental +
 characterization +
 Ecological characterization

* Units of new systematic → Population / sub - species.

Nomenclature

A. Local Name / Vernacular Name -

- * Generally it is not used in study purpose.
- * Because it is Not universal
- * Formation of local name on the basis of local language or Local area.

B. Scientific Name

- * It is generally used in study because it is Universal.
- * Formation of Scientific Name is mainly based on some scientific rules.
- * Types =>

1. Polynomial Nomenclature →

BASIS → Morphological Characters.

→ Not used in study.

2. Trinomial Nomenclature →

- It was proposed by Lamarck.
- Acc. to it 3 components are present in name of Organism.

A		Genus
B		Specific epithet
C		- Sub species (Animal) - Variety (Plant) - Strain (Bacteria)

* In case of Bacteria strain is subdivided into serotype.

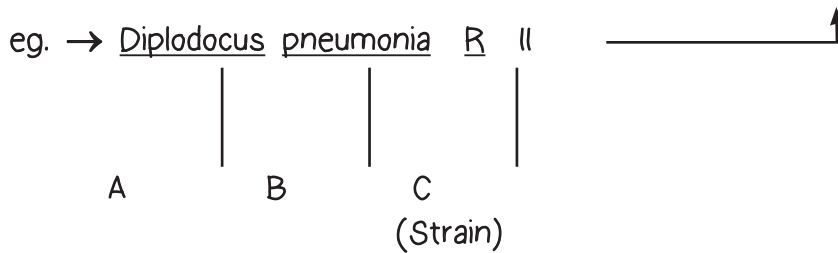

e.g. → Corves splendens _____ Indian Crow

Gorilla _____ Gorilla

Homo sapiens _____ Human.

C. Binomial Nomenclature →

* It was proposed by Carolus Linnaeus.

* Acc. to it 2 components are +nt in name of Organism

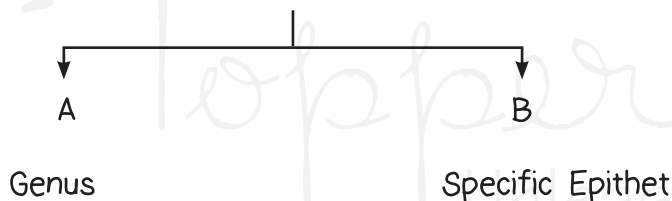

* If species diversity is high then trinomial nomenclature is used.

* Agencies for Nomenclature for Organism →

* **ICBN** - International code of botanical nomenclature.

1961 - 1st publication.

1975 - change in ICBN

1978 - 2nd Publication.

* **ICZN** - International Code of Zoological Nomen.

1964 Publication

* ICNB - International code of Nomenclature for Bacteria.

* ICNCP - International code of nomenclature for cultivated plants.

* ICVN - International code of viral Nomenclature

Q. Which of the following agencies are responsible for nomenclature Of plants.

1. ICNB
2. ICBN
3. ICNCP
4. More than 1 option is correct.

Ans. (4)

Rules of Nomenclature →

- * 2 components Present.
- * 1st comp - Genus | 2nd → sp. Epithet.
- * Language - Latin
 - Because it is Scholar language of Linnaeus
 - Dead language
 - Synonyms absent in Latin language.
- * Scientific name printed in italics which represent the Latin origin of name.
- * Both components are separately underlined.
- * 1st letter of genus - capital
- 1st letter of sp. Epithet - small.

e.g. →

Naja naja Linn

Or

Naja naja LINNEAUS

- * Scientist name printed at the end of specific Epithet any symbol like comma (,) dot (.) are absent in b/w specific Epithet & scientist name.
- * Year is placed at the end of scientist name comma (,) is +nt b/w scientist name & year.

Naja naja Linn., 1758

- * If more than 1 component is +nt in specific Epithet then both components joins with Hyphens (-) and underlined.
 - *Hibiscus rosa-sinensis*
 - *Capsella bursa pectoris*
- * Generally later limit of every component is 3-12.
Exception → *Riccia Pathankotensis*

The Living World

- * Principle of Priority | Synonyms →
- * If any organism having more than 1 scientific name then that name is not valid which was published before 1753 & 1758.

Books of Linnaeus



1. Hortus Uplandicus (first book of Linnaeus)
2. Species Plantarum
 - Contains scientific name of plants
 - 1st May 1753 - Published.
3. Systema Naturae (contains scientific name of Animals)
 - 1st Aug 1758 - Published

- * The 1st name after the 1753 or 1758 is valid scientific name for organism.
- * Other all names are considered as synonyms for organisms.

≠ Tautonyms → if genus & sp. Epithet is same.

Only +nt in Zoological Nomenclature but not allowed in Botanical Nomenclature.

- *Naja naja*
- *Gorilla gorilla*

≠ Autonyms → if specific Epithet and sub species / variety are same.

- *Gorilla gorilla gorilla*
- *Corvus splendens splendens*
- *Homo sapiens sapiens*
- *Acacia nilotica nilotica*
- *Brassica oleracea capitata*

Q. Which of the following example represent the autonym condⁿ in animal →

- | | |
|-----------------------------|-------------------------------|
| 1. Naja naja | 2. Rattus rattus |
| 3. Acacia nilotica nilotica | 4. Corvus splendens splendens |

Homonyms → if one scientific name is used for 2 different organism.

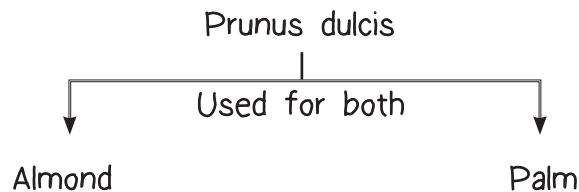

Taxonomic Categories →

* Every organism is classified into a multiple stage process in which every stage represents the a single taxonomic category.

Types of taxonomic categories.

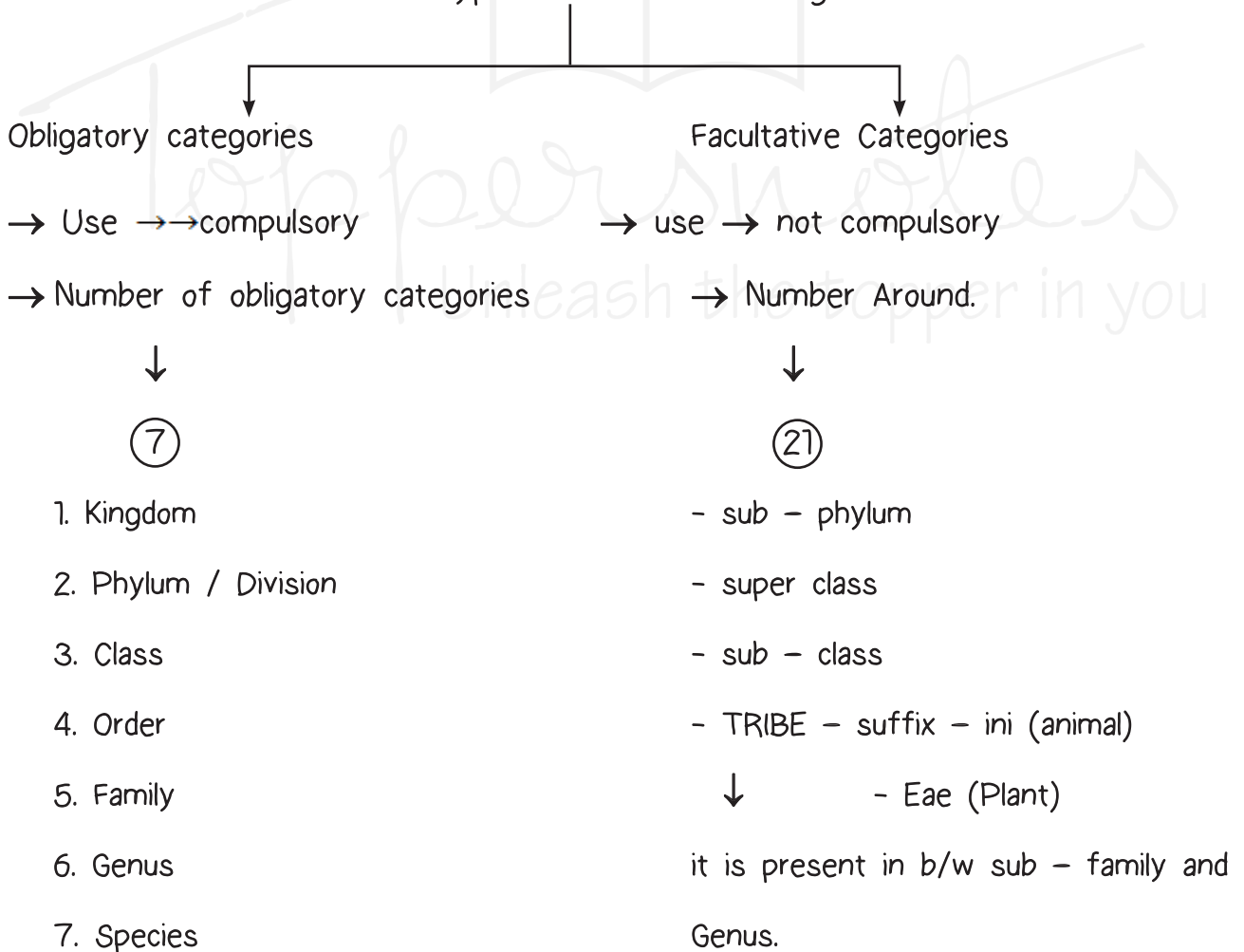

The sequence of categories may be Be Ascending / descending.

The Living World

- * Decision of family is mainly based on Vegetative + floral character (Reprod).
- * Reproductive character is mainly in place of rapidly used in classification because vegetative character are easily modified acc. to environmental condⁿ.

